

NORTHERN LIGHTS,
LAKE MINNETONKA AND
MUSTANG DISTRICTS
PRESENT
2009 WEBELOS WOODS
SPRING CAMPOREE
AT STEARNS SCOUT CAMP
MAY 1ST-3RD



Deadline to Register
APRIL 20th, 2009

INFORMATION PACKET

Register for W³ Online!

http://www.lakeminnetonkadistrict.org/lakeminnetonkadistrict_239.htm

Lake Minnetonka	<u>Patti Czech</u>	(763) 231-7223
Mustang	<u>John Knutson</u>	(763) 231-7224
Northern Lights	<u>Andrea Pengra</u>	(763) 231-7226

General Information:

Event Rules	Scout Oath and Scout Law
Event Scoring	Troops, patrols and scouts will be judged on their patrol method, scout spirit and participation. Scout Spirit will be evaluated in scoring on skill events.
Check-in	Troops can begin to arrive Friday evening, or Saturday morning, See schedule. Please have your campout roster ready at check-in. Online <u>registration</u> needs to be complete before April 20 th
Fires	Check Stearns Scout Camp Fire Policy
Garbage	Pack it in, pack it out. No littering will be tolerated!
Latrines	Permanent latrines on site
Water	Water is available at camp
1st Aid	Each troop should be able to care for minor injuries. Major injuries will be attended to by staff at Head Quarters. Please have the proper medical paperwork handy for everyone. <u>Health Form</u>
Fees	\$15 per Boy Scout, \$15 per Scout Leader, \$30 Webelos/Adult Partner
Webelos	<p>Webelos and Webelos Leaders are welcome to join us Saturday May 2nd 2009. Allow extra time for parking and arrival on Saturday. Check-in will begin at 7am with opening flag at 9am.</p> <p>Northern Lights & Mustang Districts: You are responsible for bringing your own lunch for Saturday afternoon. Saturday evening dinner with the troops will be provided.</p> <p>Lake Minnetonka District: You have a choice to connect with a troop for Lunch and Dinner; otherwise you are responsible for bringing your own lunch and dinner.</p> <p>*** All Districts *** If you plan on camping Saturday night, prior arrangements will need to be made with a Troop to for meals and camping space. If you do not know which troop to contract please call <u>Northern Star Council (763) 231.7201</u>. Or visit district specific websites: <u>Lake Minnetonka</u>, <u>Northern Lights</u>, and <u>Mustang</u>.</p> <p>Webelos DO need to <u>register</u> so we can track attendance in case of emergency.</p>
Religious Service	A scout is reverent. A non-denominational, non-sectarian service will be available. See schedule.
Uniforms	Scout uniforms ONLY. NO camouflage or military uniforms.
Scout behavior	Scouts and leader will be expected to follow the rules and regulations. Anyone not heeding these instructions will be asked to leave the Camporee. Remember, Scouting is a safe haven for boys!

Purpose of Webelos Woods as a District Event:

To aid the Webelos to Scout Transition by introducing 4th and 5th grade Webelos, their parents and their leaders to what Boy Scouting has to offer, and creating an excitement to transition into a troop.

This will be accomplished by taking activities and recognitions from the Webelos Scout program and showing how these activities and recognitions TRANSITION to the next level of challenge, excitement and FUN! Webelos will be able to EXPERIENCE Webelos and Boy Scout activities listed with TWO STARS (**). Activities and demos listed with ONE STAR (*) will be presented to them or be on display for them.

Event Covers Requirements:

Outdoorsman	Readyman	Communicator	Map & Compass BL
5. Leave no trace	2. Explain first Aid	3. Invent a story	1. Show how to orient map and 3 points
7. Fire safety	4. Heimlich		2. Explain how a compass works
8. Cooking and cleanup	12. Explain first aid kit		
10. Whip and fuse rope	13. Tell where accidents happen	Totin' Chip	
11. Knots	15. Attend First Aid Demo		
12. Visit Boy Scout camp			

Boy Scout troops and activity station leaders & display / midway area people arrive to set-up Friday night. Lake Minnetonka District will have an option for Boy Scouts to work on Merit Badge Requirements in the Activities Area. All Districts will have a camporee style competition Saturday afternoon.

District Activities: Troop Led – Webelos LEARN then DO 30 Minutes at each Station

Station 1- Outdoorsman Activity Pin – 15 minutes	Station 1 – Pioneering Merit Badge/Tenderfoot – 15 minutes
1. Whipping/fusing rope ends **	1. Make rope **
2. Knots: half hitch, square, taut line hitch **	2. Tripod (sheer) lashing **
Station 2 – Map/Compass Belt Loop	Station 2 – Orienteering Merit Badge
Must complete items in 30 minutes	1. Try an orienteering course with 6 control points **
1. Show how to orient a map & find 3 landmarks **	Football field size area
2. Explain how a compass works **	2. Measure height & distance
Set-up 6 mini courses to allow for mini groups	
Station 3 – Outdoorsman Activity Pin – 15 minutes	Station 3 – Cooking Merit Badge – 15 minutes
1. Cooking in camp **	1. Utensil-less cooking *
2. Dutch oven, washing	2. Solar ovens, freeze dried, foil
3. Dough on a stick	3. Learn and show proper bear bag
Station 4 – Wilderness Survival – 15 minutes	Station 4 – Survival – 15 minutes
1. Building a fire, types of fire **	1. Edible plants
2. String burning contest	2. Find it: Pine needle tea, dandelions, cattails, insects

Midway & Display Area:

Booth: Related to Activity Pins	Booth: Related to Merit Badges	District In charge
Outdoorsman	Camping & Wilderness Survival	Mustang
Camping out, away from home, packing, equipment **	Personal Survival kit *	
	Improvised natural shelter *	
Totip Chip		Lake Minnetonka
Hatchet, axe & saw area *		
Outdoorsman	Camping & Wilderness Survival	Mustang
Building a wood fire *	Starting fires with out matches *	
Fire Starters *		
Readyman	First Aid	Northern Lights
Cuts, Scratches, and burns *	Hypothermia, Build a stretcher, AED *	
Communicator	Communications	Northern Lights
Secret codes **	Create a sales plan to get other to join Boy Scouting! **	
Write a story for your friends about W3 **	JOTA (Ham radio) **	
Archery	Archery	Lake Minnetonka
Make an Arrow **	Make an Arrow **	

Webelos Woods 2009

Mustang

Activity Stations

- 1 Outdoorsman-Pioneering Merit Badge
- 2 Map & Compass-Orienteering Merit Badge
- 3 Outdoorsman-Cooking Merit Badge

Lake Minnetonka

Activity Stations

- 1 Outdoorsman-Pioneering Merit Badge
- 2 Map & Compass-Orienteering Merit Badge
- 3 Outdoorsman-Cooking Merit Badge

Display Midway

Display Areas

- 1 Outdoorsman-Camping & Wilderness Survival Merit Badge
- 2 Totin' Chip
- 3 Outdoorsman-Camping & Wilderness Survival Merit Badge
- 4 Readyman-First Aid Merit Badge
- 5 Communicator-Communications Merit Badge
- 6 Archery Merit Badge
7. Guided Scavenger Hunt-Northern Lights

Northern Lights

Activity Stations

- 1 Outdoorsman-Pioneering Merit Badge
- 2 Map & Compass-Orienteering Merit Badge
- 3 Outdoorsman-Cooking Merit Badge
4. Wilderness Survival

What you need to know

Webelos

Allow extra time for parking and arrival on Sat am. Check-in will begin at 7am with opening flag at 9am.

You are responsible for bringing your own lunch for Sat afternoon.

If you plan on camping Saturday night, prior arrangements will need to be made with a troop.

Saturday evening dinner with the troops will be provided.

Come prepared rain or shine for a full day of fun!!

Troops

Troops can begin to arrive Friday night.

Saturday Evening dinner will be provided.

Troops will have the following activities:

Helping run activity stations and Midway for Webelos

Saturday, building a catapult (trebuchet) for evening competition

Judged on distance, workability, lashing, originality

Saturday Evening: Cooking contest: Iron Chef style The district will provide a "mystery" ingredient that must somehow be incorporated into the dish

Enter either entrée or dessert category

Come prepared to impress us with your cooking skills

Judged on Originality, Presentation, Cooking method and best use of mystery ingredient.

Troop Information

During the day Troops will be responsible for helping to staff activity events, building a catapult and preparing for cooking contest.

Here are the staffing needs:

Station 1, 2, 3, 4 (Refer to district activities section)

Midway 1, 2, (Refer to Midway and Display Area Section)
Midway #3 Guided scavenger Hunt -1 hr in length

Here is some information for the catapult portion.

Materials:

Staves (wooden poles) WILL BE PROVIDED by district
Binder twine for basket of thrower assembly and lashings --Troop must bring
Catapult diagram and instruction sheet (provided by each patrol)
Boy Scout handbook

Preparation:

1. You have all day to build and test. Must be ready for competition by 5pm
2. The patrol leaders will be responsible for their patrol and the construction of the catapults.
3. Lashings that you may need to know for this activity are found in chapter 5 of the Boy Scout handbook. Lashings you may need to use include the square, shear, diagonal, round, and tripod lashings.

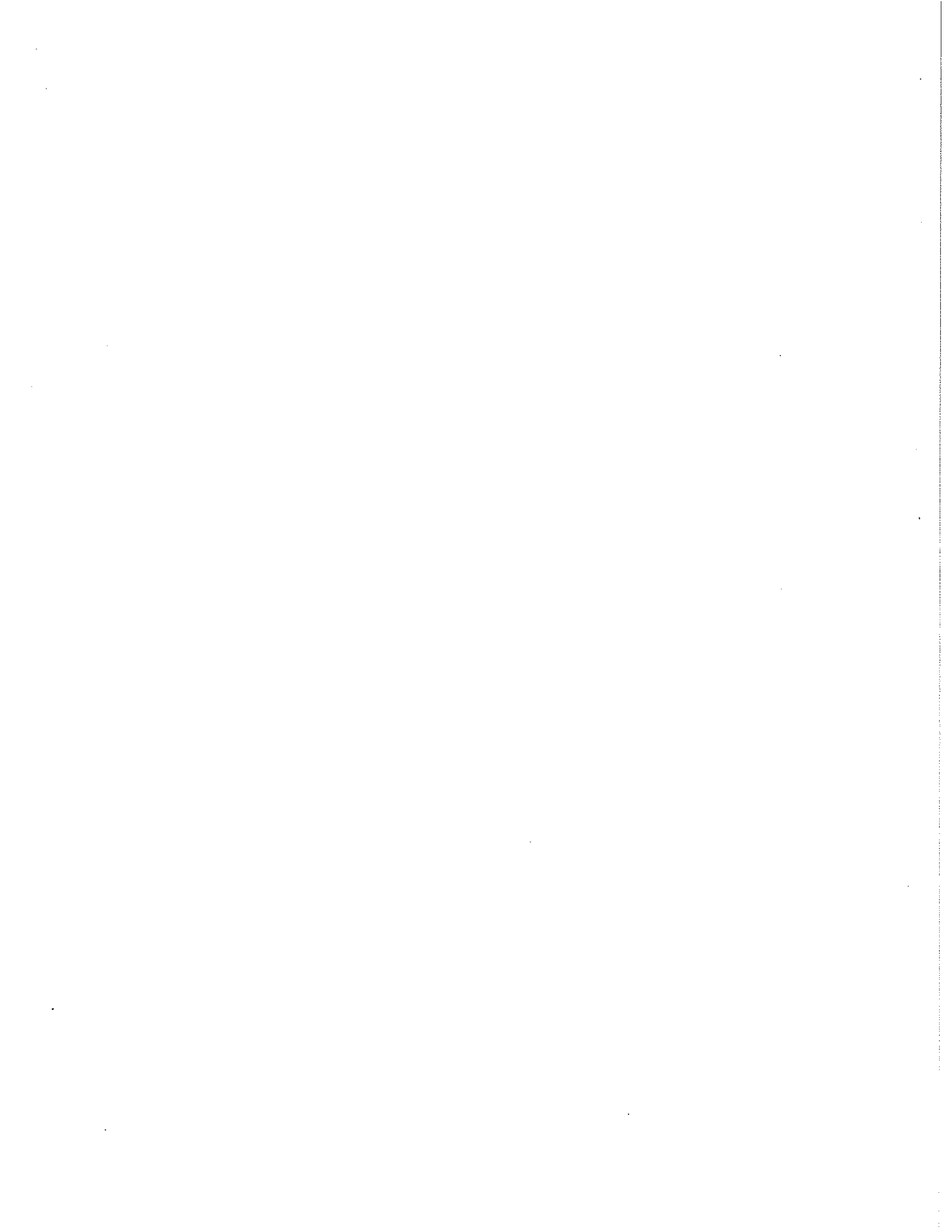

Sample Diagram:

Use these as only a guide. You may want to modify these diagram.

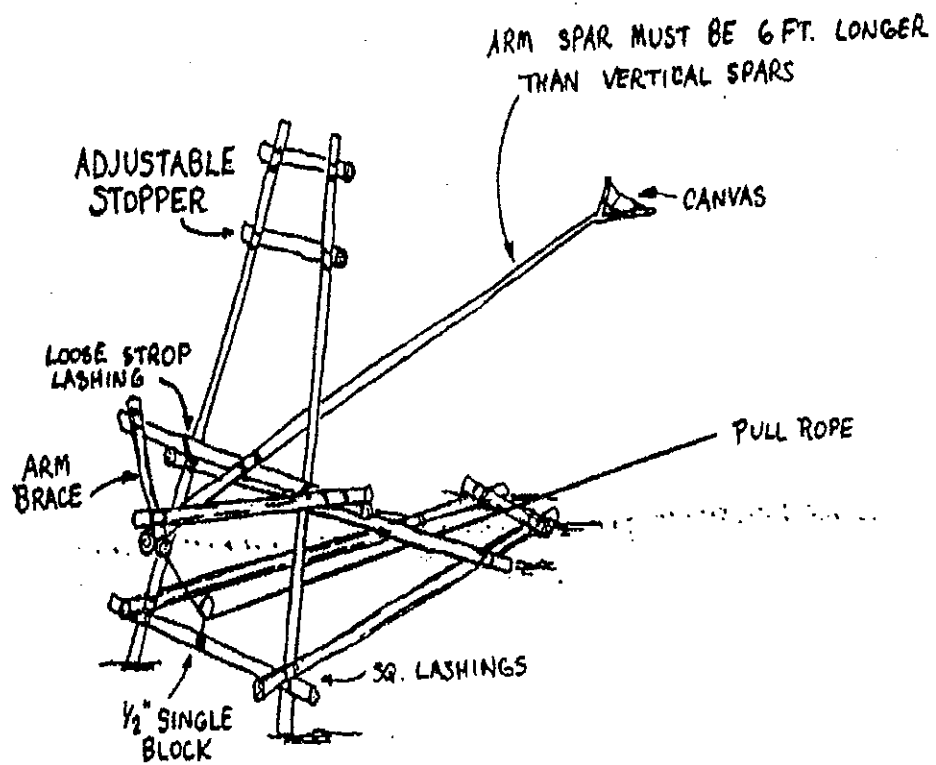
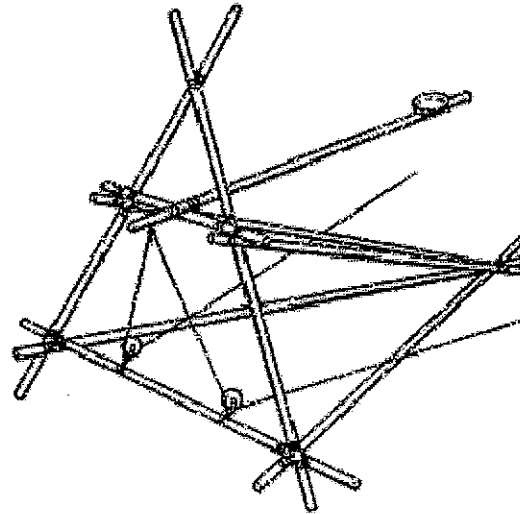

CATAPULT V3.1

2 Alternate Bases

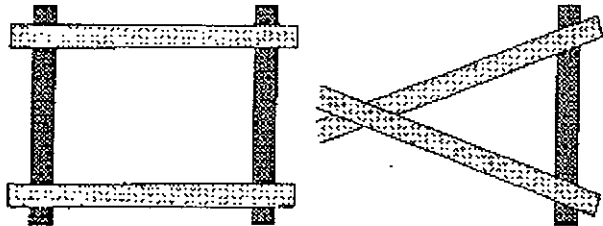

Construct one of these two bases. The triangular base is somewhat more preferred for its stability, mobility, and for the chance to use more diagonal lashings.

Frontpiece

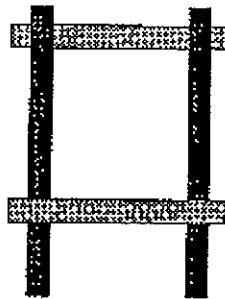

Construct the frontpiece.

Arm Assembly

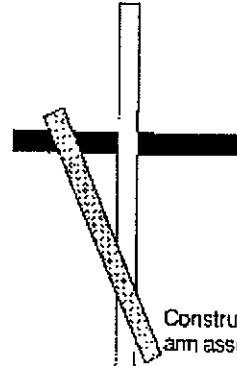

Construct the arm assembly.

Adding the Diagonals

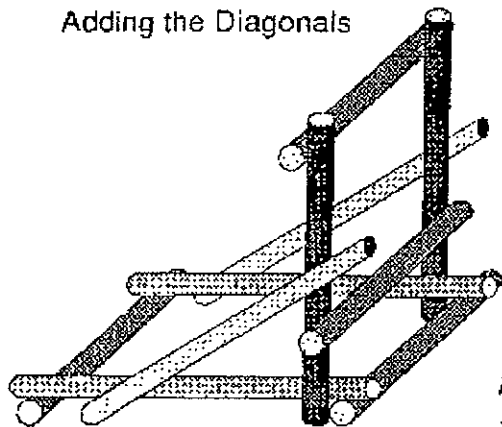

Lash the frontpiece to the base using square lashings and add the diagonals. Diagonals should extend approximately three pole widths past the frontpiece to allow the arm to rest in the slot and rotate without rolling out. The point of intersection should be below the midpoint of the top and bottom crosspieces of the frontpiece.

Parts List

The following parts list is for a medium-large 'putt. Actual 'putts have been built with anything from broomsticks to 20-foot+ poles. The design is quite flexible and should be altered to fit the resources (both poles and Scout-horsepower) that you have available. More "efficient" (i.e. farther-throwing) 'putt designs exist, but this simpler design is more easily mastered by Scouts and will hold up to many successive, successful throws.

- 5 - 10' poles (for base, frontpiece, diagonals)
- 4 - 5' poles (for base, frontpiece) (3 if triangular base)
- 2 - 7' pole (for arm)
- 1 - 15' pole (for arm)
- 15 - lashing ropes (14 if triangular base)
- 1 - 30' pull rope
- 1 - 5"-7" diameter bucket, 4" tall
- 2 - nails

The bucket is attached to the arm by nailing or by lashing through holes near the bottom.

Final Assembly

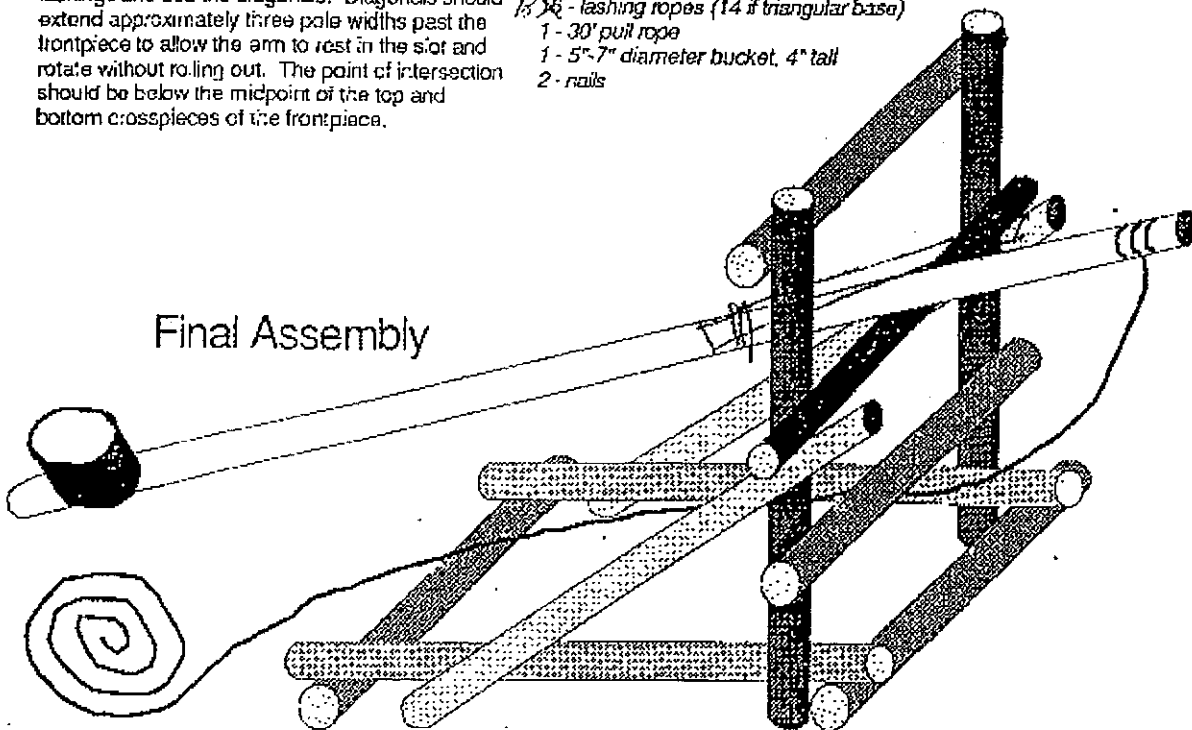

Connect the arm to the bucket (see above). One of the pull ropes under the top or front piece is attached to the bucket.

Troop Campsite Inspection:

Part of scout camping is maintaining a safe and organized campsite. Troop campsites will be judged on the following criteria:

I. Campsite Identification

- A _____ American Flag (5 points)
- B _____ Troop Flag (5 points)
- C _____ Entryway with troop sign (5 points)

II. Campsite and sleeping arrangements

- A _____ Tents pitched by patrol (5 points)
- B _____ Campsite neat and orderly (5 points)

III. Health, safety and sanitation

- A _____ Garbage picked up (5 points)
- B _____ Dishes washed and put away (5 points)
- C _____ Cooking area clean (5 points)
- D _____ First aid kit easily seen (10 points)
- E _____ Fire attended or out, cold to touch (10 points)
- F _____ Fire located in proper area (in relation to the kitchen, tents, etc.)
(10 points)
- G _____ Fuels properly stored (in closed containers, away from fires, etc.)
(10 points)
- H _____ Food properly stored (10 points)

IV. Menu planning, Duty Roster

- A _____ Menu for all meals (5 points)
- B _____ Duty roster posted (5 points)

V. Scout Spirit Project

- A _____ Units may gain extra points for creative/best welcome to the Webelos (20 points max).

Roster & Medical Forms:

Please remember to have a complete roster of people in attendance ready when you check in at the Camporee. Please make sure you have medical forms available for each person in attendance.

Registration – Online Payment:

Register & Pay for W3 Online!

http://www.lakeminnetonkadistrict.org/lakeminnetonkadistrict_239.htm

Lake Minnetonka Patti Czech (763) 231-7223

Mustang John Knutson (763) 231-7224

Northern Lights Andrea Pengra (763) 231-7226

Unable to pay online:

Download and print online document

Submit with payment

Make checks payable to: **Northern Star BSA**

Attention: W3 Webelos Woods Spring Camporee 2009

Northern Star Council BSA

5300 Glenwood Avenue

Golden Valley, MN 55422